

北京理工大学软件学院

School of Software at Beijing Institute of Technology



交



交





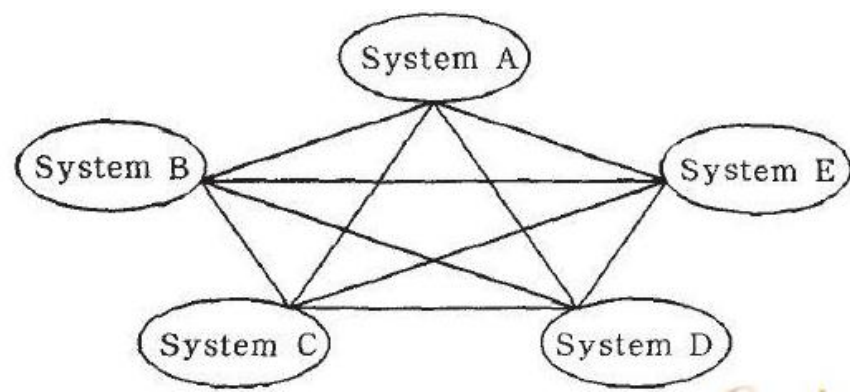

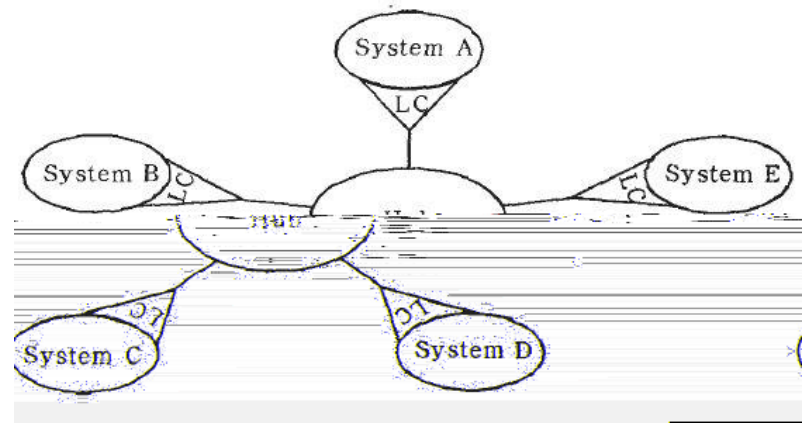

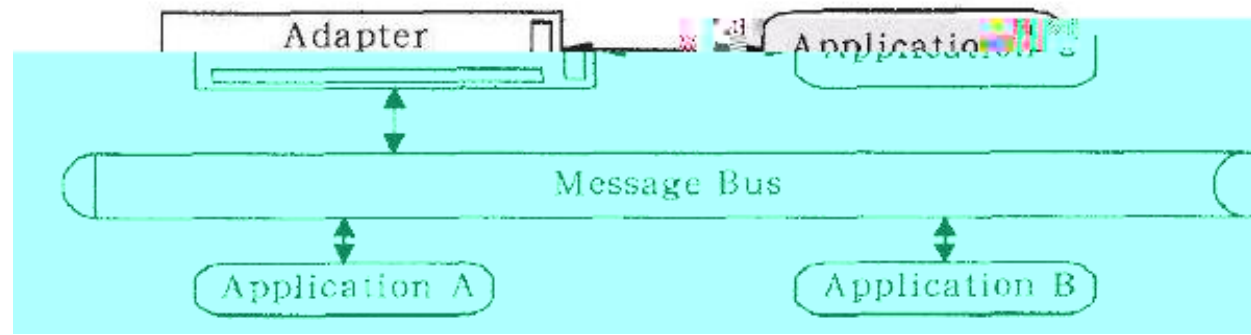

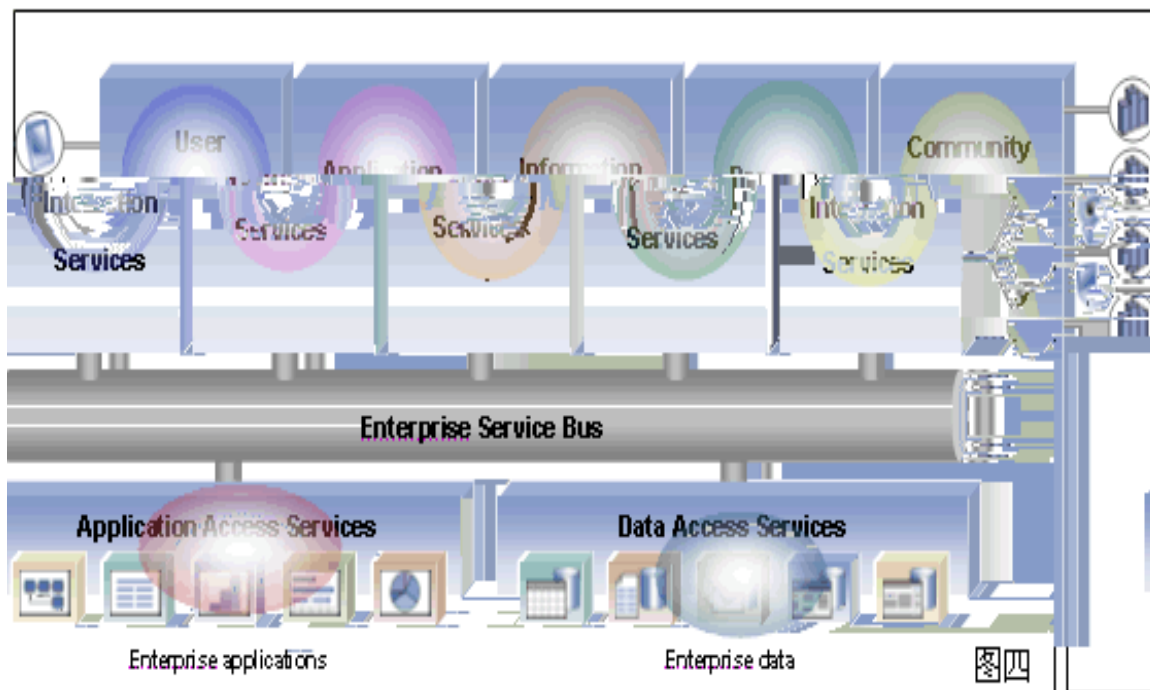

交



及 及 及
及及 及 及
及 及 及 及
及及 及
及 及 及
及 及
及 及 及
及 及 及
及 及 及

交



于

及

于

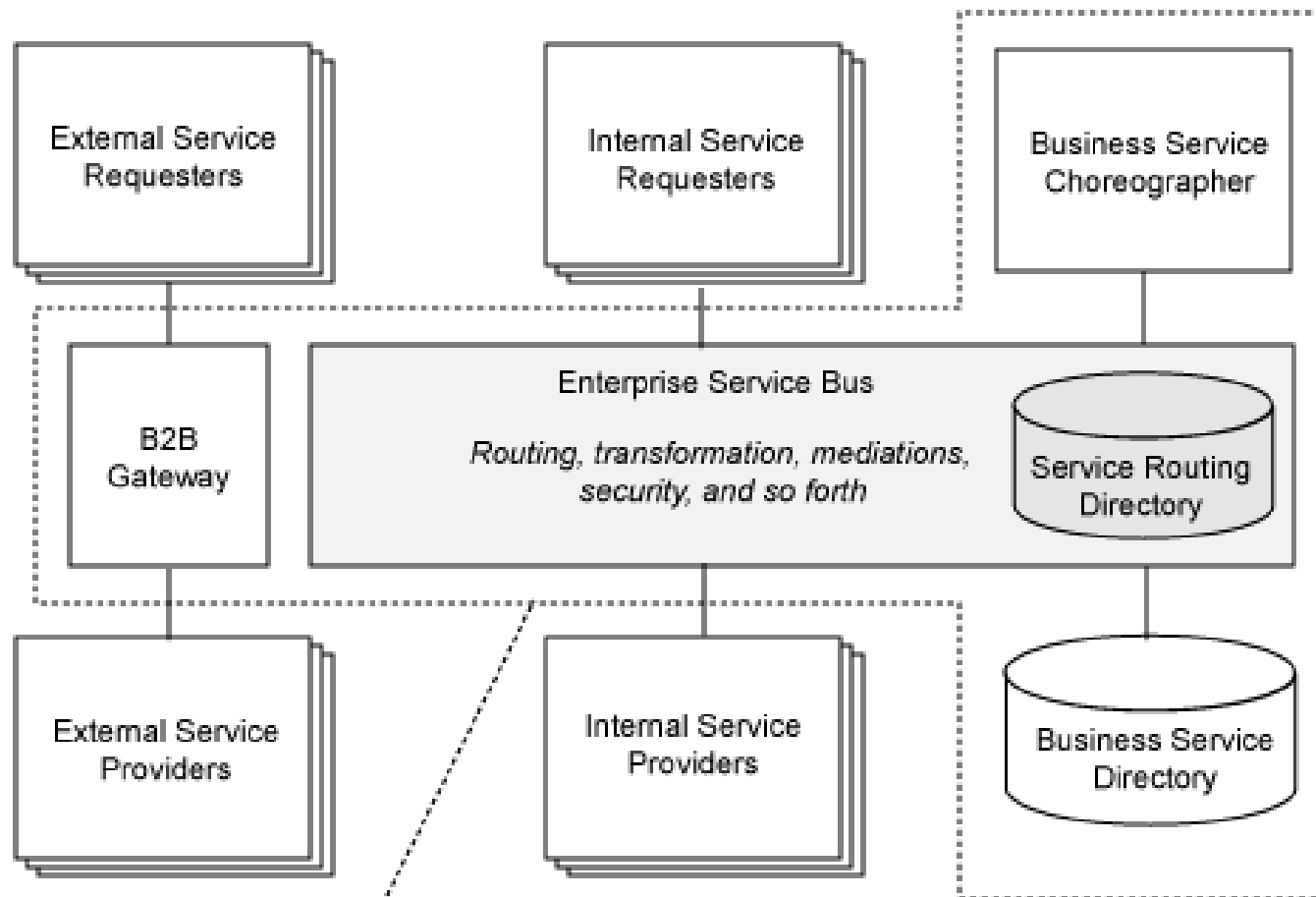

Infrastructure components
for service-oriented
architecture

于

及

及 及

及

于

及 及

及 及

于

交



•
•
• O M E MD
•
•
•
•
•

•
• O O
•
•
• O M
E 与
•

•
•
•
• E 与
•
•
•
•
•
•

•
• O
•
• O E 与

-
-
-
-
-

00

-
-
-
-

-
-
-
-
-
-
-

与

-
-
-
-
-

-
-
-
-
-

-
-

OM





交



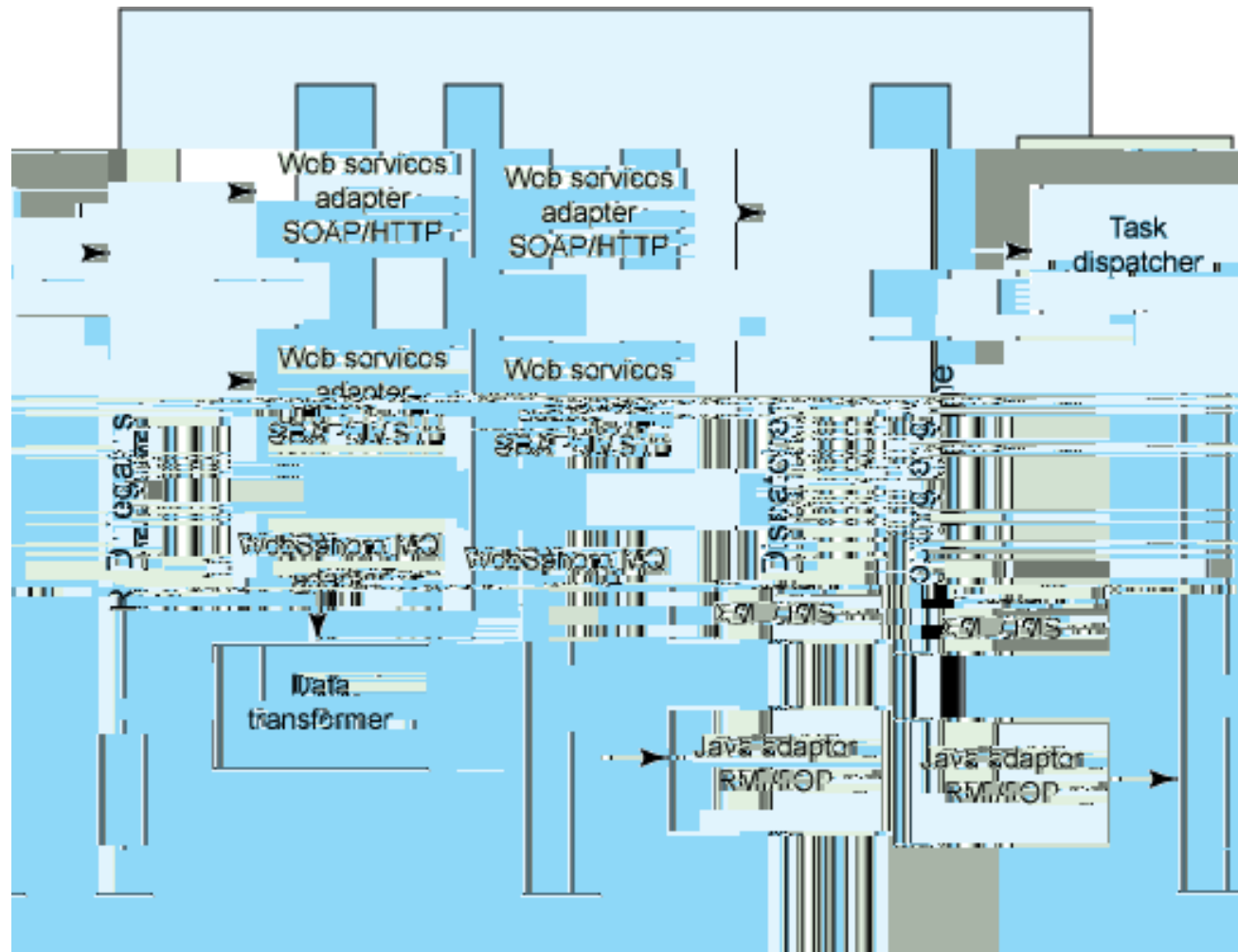

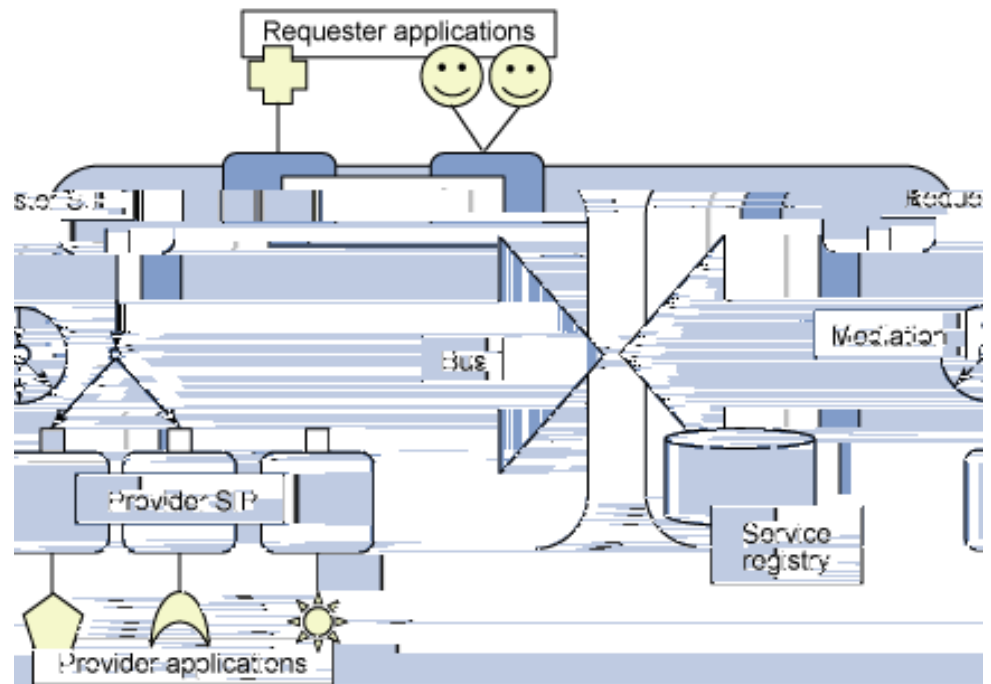



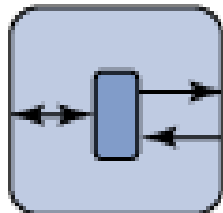

Request /
response

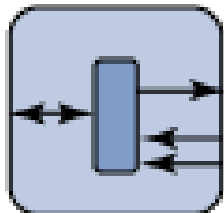

Request / multi
response

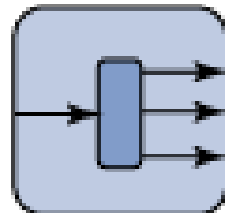

Event
propagation

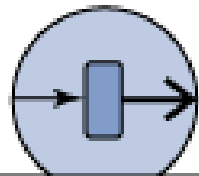

Protocol
switch

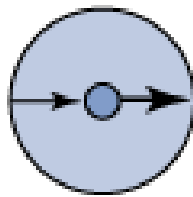

Transform

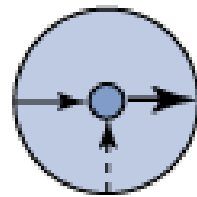

Enrich

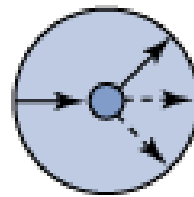

Route

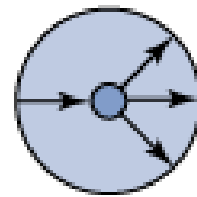

Distribute

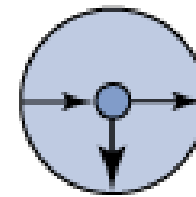

Monitor

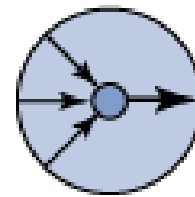

Correlate





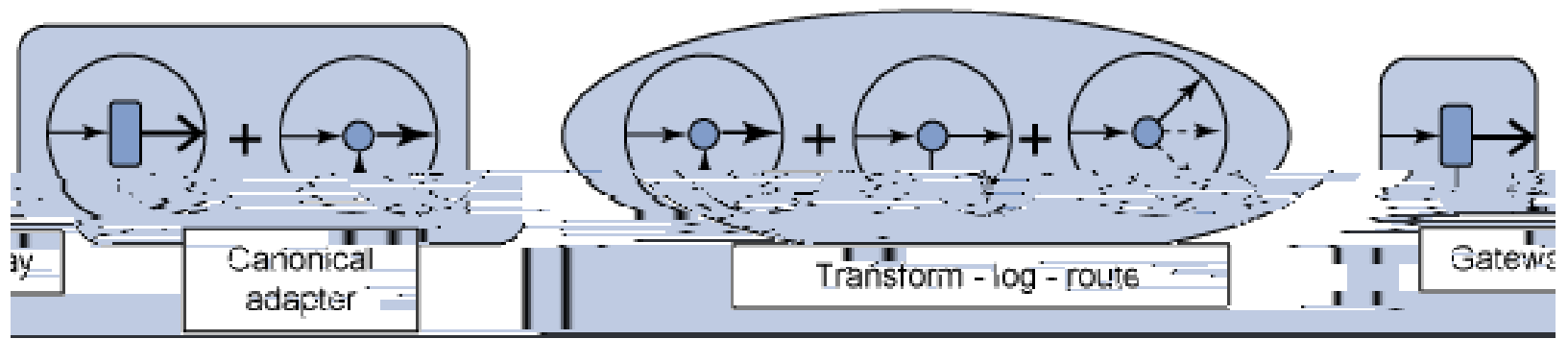

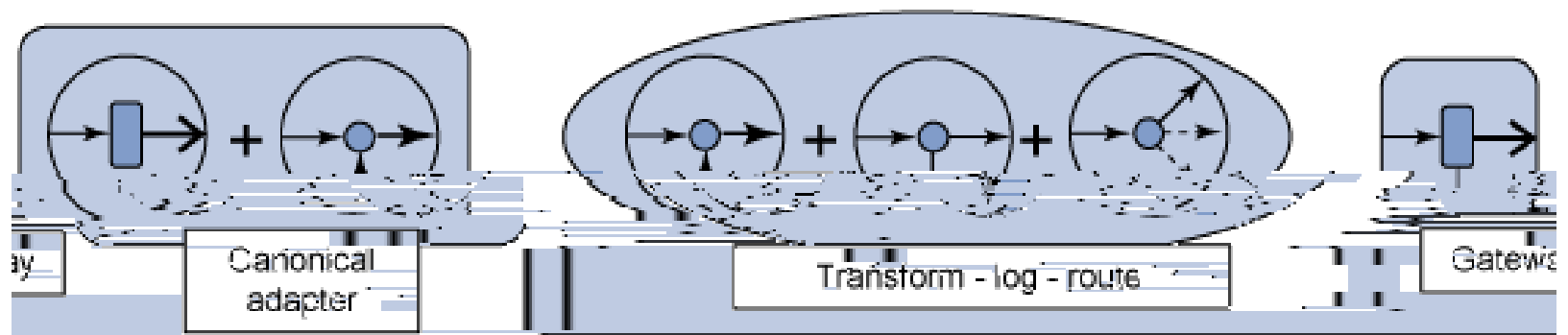

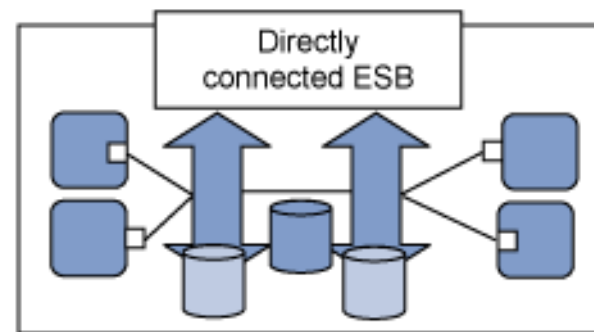
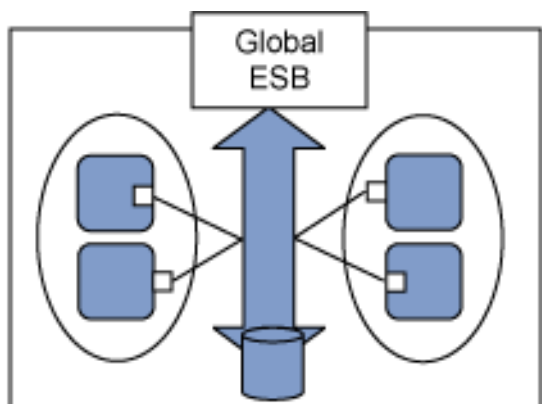

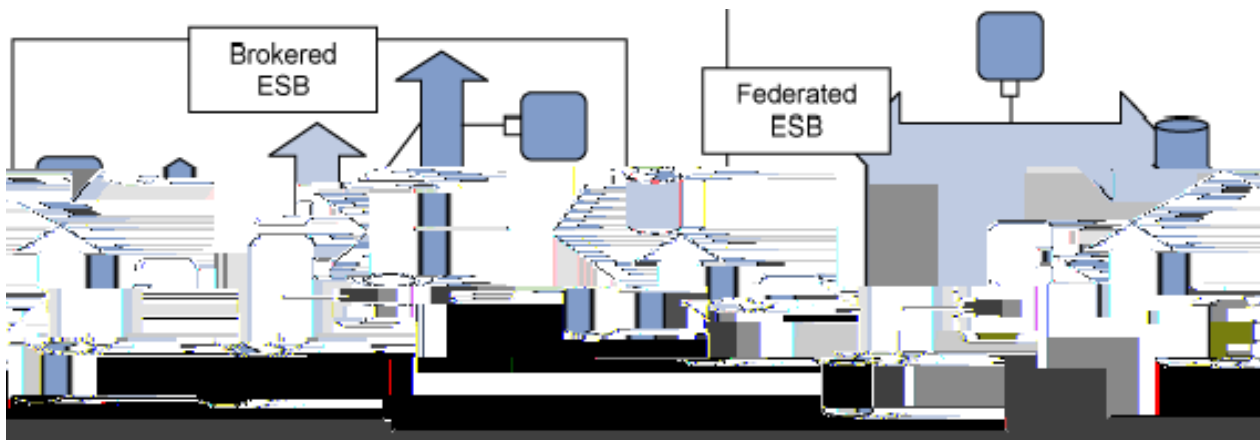

交



及
及

交



